

**EN** Astronomical time switch

SELEKTA 171 top2 RC

1710100

SELEKTA 172 top2

1720100



## 1. Basic safety information 3

## 2. Proper use 3

### Disposal 4

## 3. Installation and connection 4

### Connecting the cable 6

### Disconnecting the cable 6

## 4. Device description 7

### Display and buttons 7

### Operating instructions 8

### Overview of navigation menu 9

### Initial operation 10

## 5. Settings and functions 11

ASTRO menu 11

Changing the astro time/  
location 13

Setting the offset function 14

Programming fixed switching time  
(e.g. in standard program) 15

Special programs 16

Setting summer/winter time 20

Switching perm ON / OFF 21

Setting holiday function 22

Setting ext input 23

Activating PIN code 24

Setting manual or permanent  
switching 25

Hour counter 26

Time signal can be received



with appropriate top2 RC antenna 26

Using the OBELISK top2 memory card 27

Resetting the time switch 29

**6. Technical data 30**

**7. Contact 31**



# 1. Basic safety information



## WARNING

**Danger of death through electric shock or fire!**

- Installation should only be carried out by a qualified electrician!

- The device is designed for installation on DIN top hat rails (in accordance with EN 60715)
- Power reserve (10 years) is reduced if memory card is inserted (using battery power)
- The device corresponds to type 1 STU in accordance with IEC/EN 60730-2-7
- Zero-cross switching for relay-saving switching and high lamp loads
- 3 special programs with date function per channel
- Time synchronisation via connection of an external DCF or GPS antenna (SELEKTA 171 top2 RC)



OBELISK top2 memory card: Avoid mechanical stress or contamination during storage/transportation

# 2. Proper use

- The astronomic time switch is for instance used for lighting equipment (roads, external staircases, display windows, entrances etc.).
- Only for use in closed, dry rooms



Do not use on safety devices, e.g. escape route doors, fire safety equipment etc.

## Disposal

- Dispose of device in environmentally sound manner

## 3. Installation and connection



**WARNING**

**Danger of death through electric shock or fire!**

- Installation should only be carried out by a qualified electrician!

## Mounting the time switch

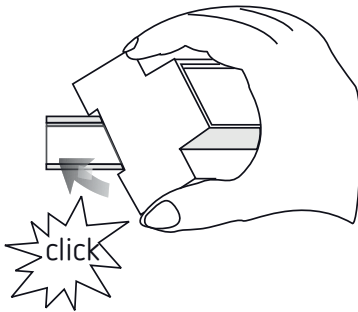

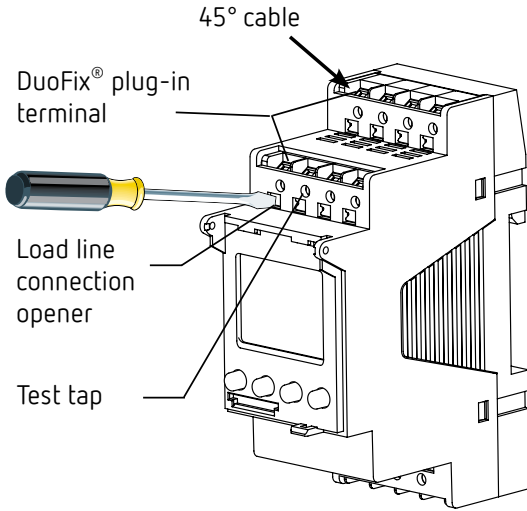

- Mount on DIN top hat rail (as defined in EN 60715)
- Disconnect power source
- Ensure device cannot be switched on
- Check absence of voltage
- Earth and bypass
- Cover or shield any adjacent live components

## Connecting the cable

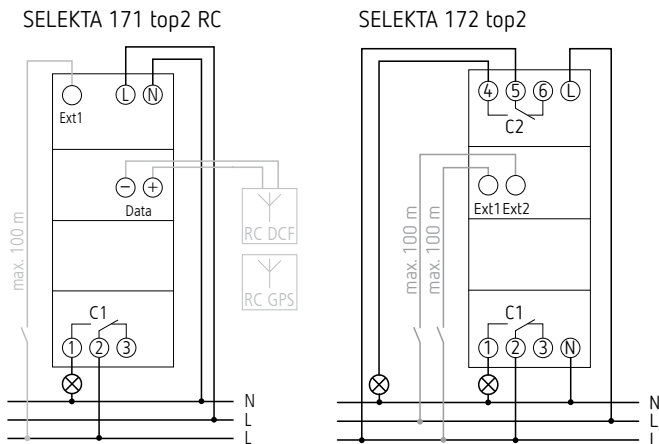

- ▶ Correct connection required for smooth function of the zero-cross switching
- ▶ Strip cable to 8 mm (max. 9)
- ▶ Insert cable at 45° in the open DuoFix® plug-in terminal (2 cables per terminal possible)
- ▶ Only with flexible wires: To open the DuoFix® plug-in terminal, press screwdriver downwards

## Disconnecting the cable

- ▶ Use the screwdriver to push the load line connection opener downwards

# 4. Device description

## Display and buttons

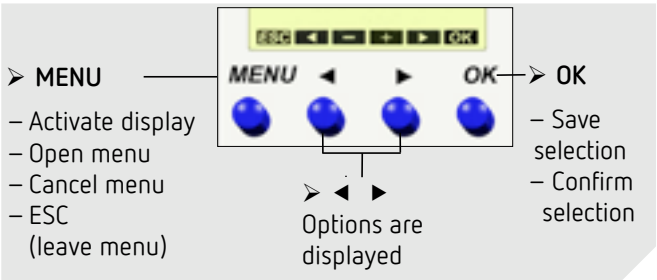
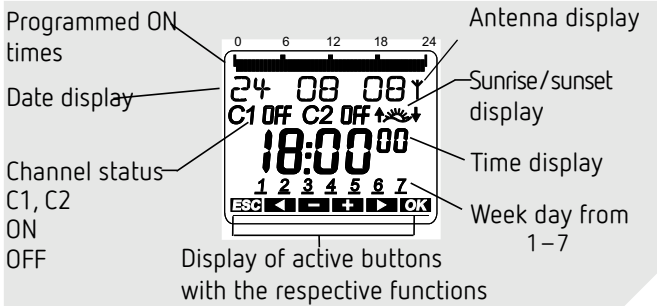



# Operating instructions

1. Read text lines  
Flashing text/symbol  
is a prompt



2. Make a decision



**YES**  
Confirma-  
tion  
press  
OK

**NO**  
Change/  
select  
press  
◀ ▶



# Overview of navigation menu

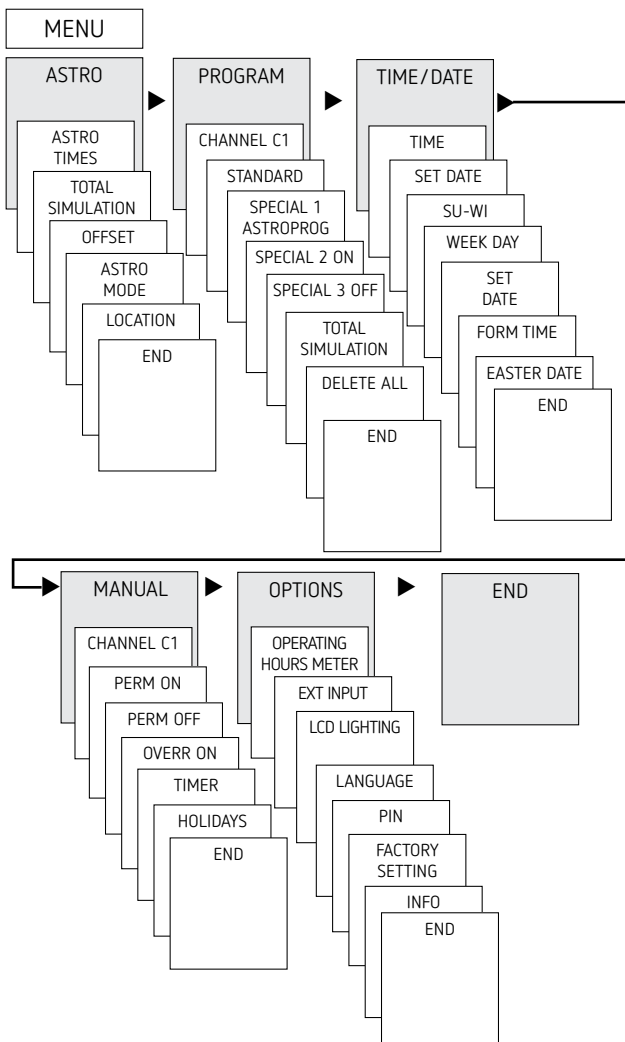

# Initial operation

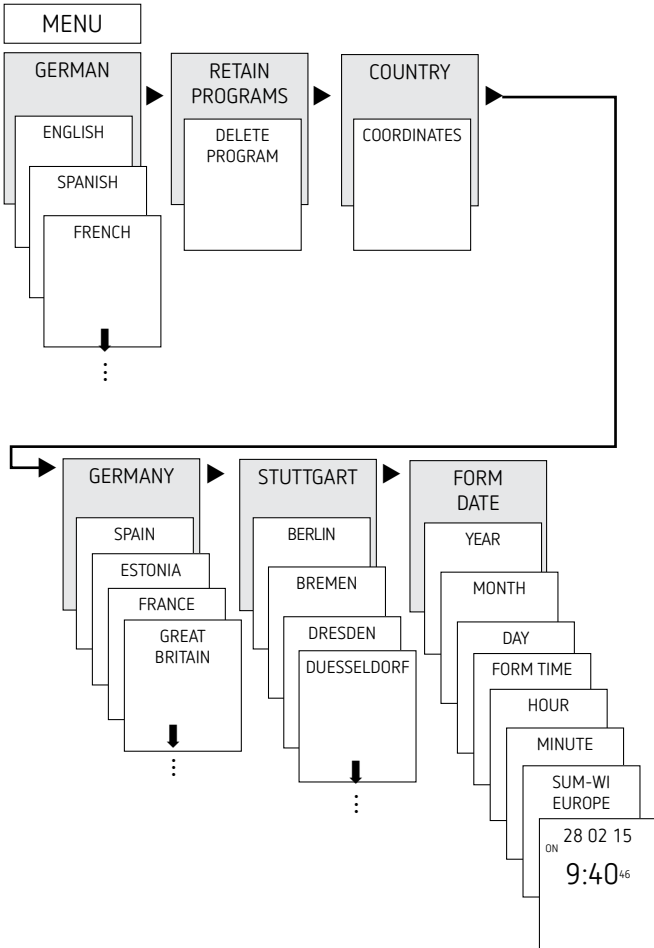

- Set language, country, town/city, date, time as well as summer/winter time (SU-WI)
- Press any button and follow instructions on the display (see figure).

## 5. Settings and functions

### ASTRO menu

In the ASTRO menu, astro times, complete simulation, offset, astro mode and position (locations) can be queried or changed.

- Astro times  
Display of the astro times (including the offset) for the current day
- Complete simulation  
Display of the switching response with a freely selectable start date (the holiday program is not shown)
- Offset  
The offset (correction value) can be used to shift the calculated astro times by  $+/- 120$  min. This means that the astro turn-on and turn-off times can be adapted to local conditions (e.g. mountains, high buildings etc.) or to personal requirements.



- Astromode
  - Evenings on, mornings off: At sunset it switches on, at sunrise it switches off (example: street lighting)
  - Evenings off, mornings on: At sunset it switches off, at sunrise it switches on (example: terrarium)
  - Astro not aktive: The astro times are ineffective (only the "fixed switching time" time switch function)
- Position
  - Setting the location by selecting a town/city or via coordinates (latitude/longitude, time zone). By using the OBELISK top2 memory card, up to 10 further towns/cities (= favourites) can be added.



## Changing the astro time/location

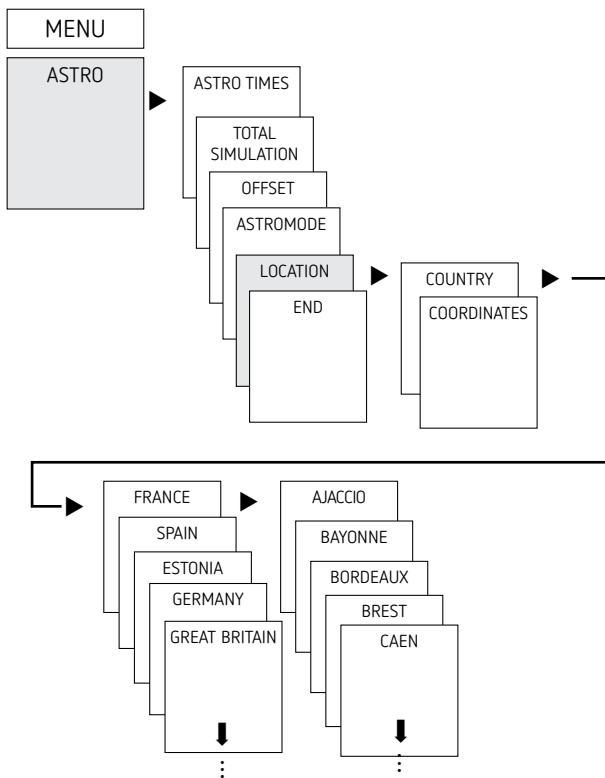

e.g. enter a different country, a different town/city

➤ Press MENU (see picture).

# Setting the offset function

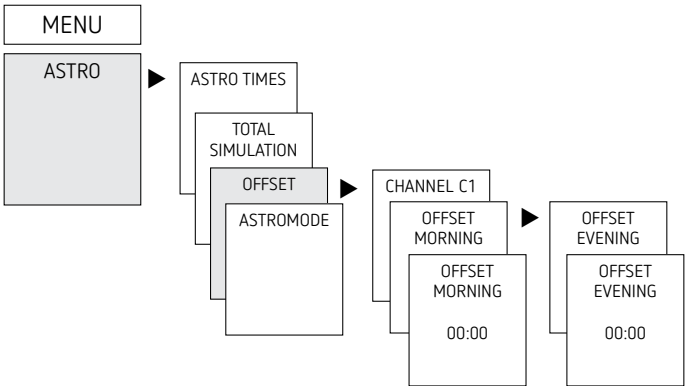

- Press MENU
- Select ASTRO and press OK to confirm
- Select OFFSET and press OK to confirm
- Select OFFSET MORNING or OFFSET EVENING and press OK to confirm
- Set the time and press OK to confirm

# Programming fixed switching time (e.g. in standard program)

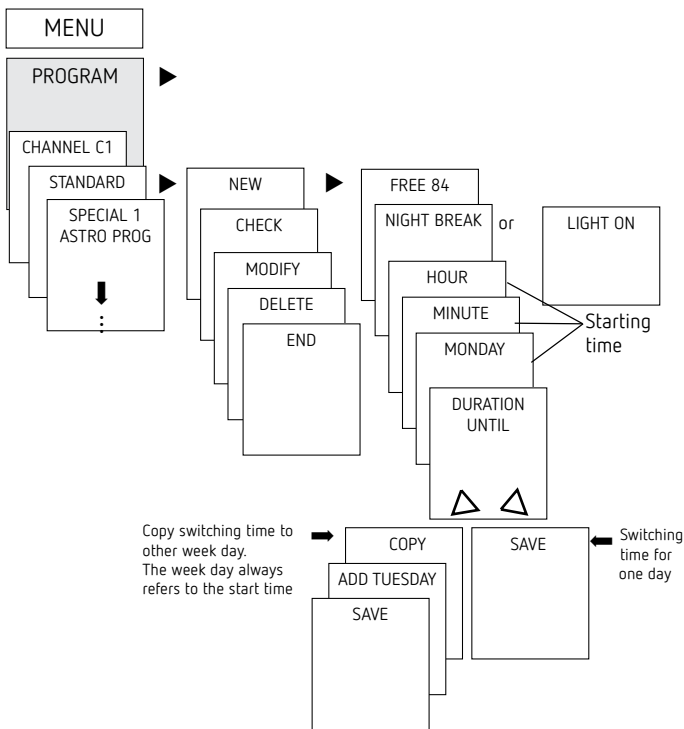

- ① A switching time always consists of a start time and an end time (DURATION UNTIL). e.g. night switch-off on Monday 11:00 p.m. – 05:00 a.m.



① There are 84 memory cells available

- Press MENU
- Select PROGRAM and press OK to confirm
- Select CHANNEL, confirm with OK
- Select STANDARD, confirm with OK
- Select NEW, confirm with OK
- Select NIGHT BREAK OFF or LIGHT ON and press OK to confirm
- Set selected switching times (hours, minutes, day) and press OK to confirm
- Select COPY or SAVE
- To save press ► and press OK to confirm
- To copy press OK



## Special programs

- The devices SELEKTA 171 top2 RC and SELEKTA 172 top2 feature 3 special programs, which can be used for calendar-dependent switching.
- Each special program can be activated over one or several date areas.
- There are 3 types of date areas:
  - Fixed date area:
    - e.g. starting time on 2015-04-02 at 04:00 p.m
    - end time on 2015-04-24 at 10:00 a.m.
  - Yearly repeating date area:
    - e.g. Christmas:
    - starting time on 24-12 at 06:00 p.m every year
    - end time on 26-12 at 11:00 a.m. every year
  - Date area depending on Easter:
    - e.g. Whit Sunday and Whit Monday:
    - starting time 49 days after Easter at 0:00 a.m
    - every year end time: 51 days after Easter at 0:00 a.m., every year

① 12:00 a.m. is programmed as 00:00 a.m. of the following day.

<b>Holidays depending on Easter in Germany</b>	
<b>Holiday</b>	<b>days before/after Easter Sunday</b>
Carnival Monday	- 48
Good Friday	- 2
Easter Monday	+ 1
Ascension	+ 39
Whit Monday	+ 50
Corpus Christi	+ 60

- Special program 1
  - **Astro times active**
  - Optional 1x night interruption
  - Optional 1x daytime switch on
  - Active in the programmed date areas
  - **Example:** The standard program switches on street lighting depending on Astro times.  
A night interruption is programmed from 11:00 p.m. to 04:00 a.m. Special program 1 is active within the date area from April 30 , 12:00 p.m. until May 1, 12:00 p.m. Since no night interruption is programmed, the street lighting will remain on all night.



- Special program 2
  - **PERM ON**
  - Always on during the programmed date areas
  - Example:** The standard program switches on lighting of a neon advertising sign only at night. The special program switches on the neon advertising sign permanently during a promotion week from 2015-04-17, 9:00 a.m. until 2015-04-24, 6:00 p.m.
- Special program 3
  - **PERM OFF**
  - Always off during the programmed date areas
  - Example:** The standard program switches on the car park lighting in dependence of the astro times. The special program does not switch on the car park lighting on July 14, from 0:00 a.m. to July 15 04:00 a.m.



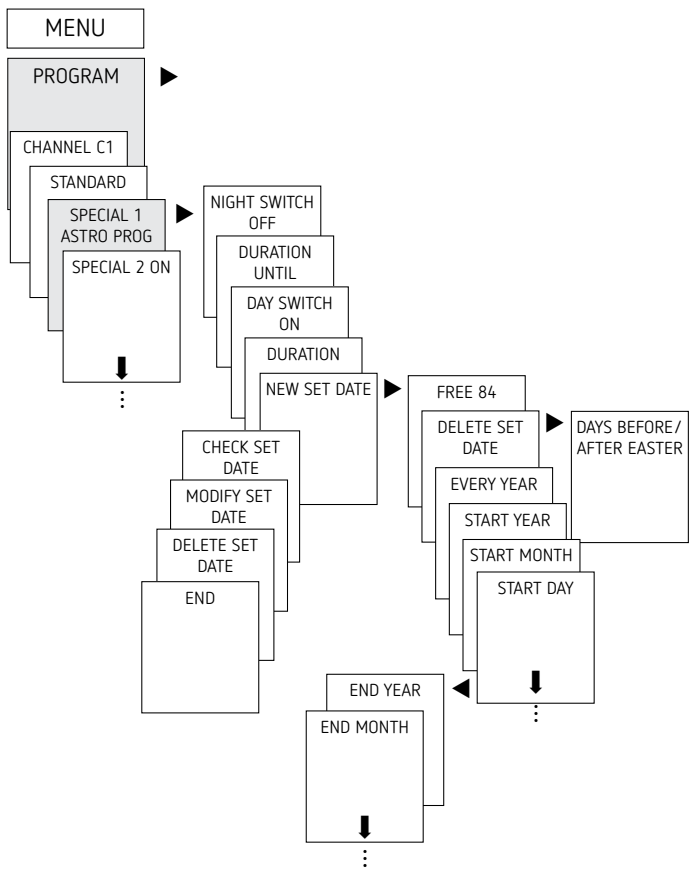

# Setting summer/winter time

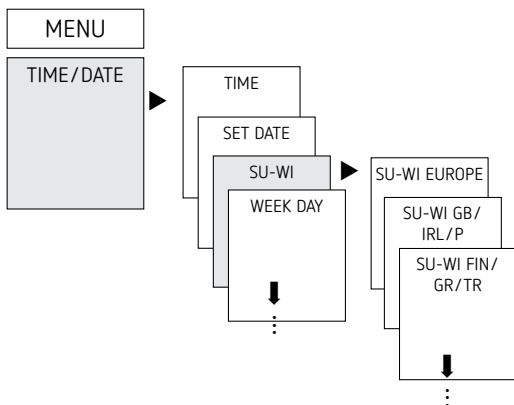

- Press MENU
  - Select TIME/DATE and press OK to confirm
  - Select SU-WI and press OK to confirm
  - Select region for the SU-WI time and press OK to confirm
- ① If a DCF/GPS antenna is used, the SU/WI change over has still to be activated.

## Switching perm ON / OFF

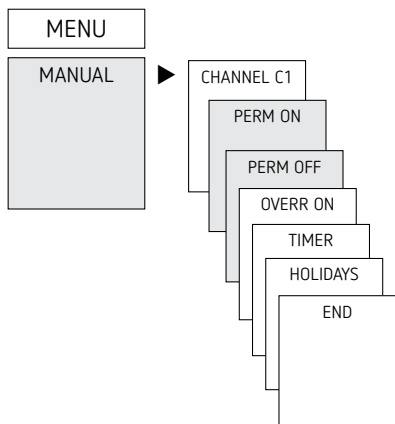

- Press MENU
- Select MANUAL and press OK to confirm
- Select CHANNEL, confirm with OK
- Select PERM ON or PERM OFF and press OK to confirm

## Setting holiday function

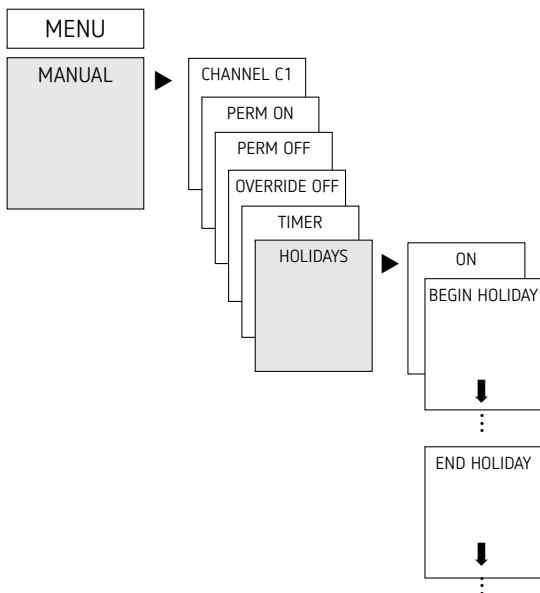

- Press MENU
- Select MANUAL and press OK to confirm
- Select CHANNEL, confirm with OK
- Select HOLIDAY and press OK to confirm
- Select ON and press OK to confirm
- Select BEGIN HOLIDAY and press OK to confirm
- Enter YEAR, MONTH, DAY, HOUR and press OK to confirm
- Select END HOLIDAY and press OK to confirm
- Enter YEAR, MONTH, DAY, HOUR and press OK to confirm

## Setting ext input

For the channel, an EXT INPUT (see figure) can be set with different functions.

3 sub-menus can be selected: not active button (function), switch (function)

- NOT ACTIVE: The ext input has no function
- PUSH BUTTON: Manual (manual control), Timer (count-down timer), and staircase light timer switch are selectable
- SWITCH: Perm on, perm off and Astro only are selectable

① If a function is activated via an external push button or switch, EXTERNAL is displayed.

- Press MENU, with ► select EXT INPUT and follow the indications on the display





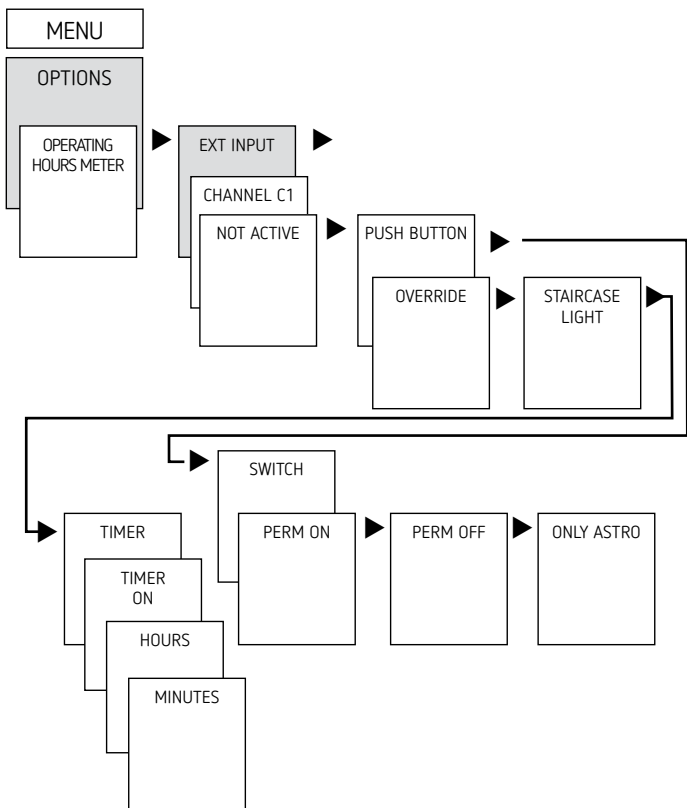

## Activating PIN code

The PIN code is set in OPTIONS via the menu.

- ① If you have forgotten your PIN, please call the Theben Hotline.
- ① Have the serial number ready!

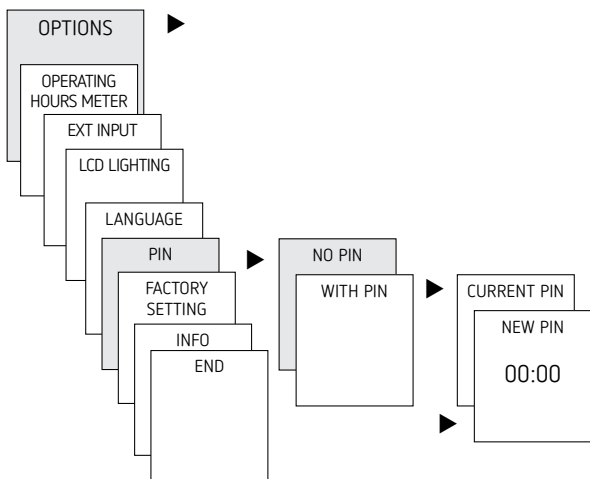

## Setting manual or permanent switching

Manual or permanent switching can be set via the menu in MANUAL or (in the automatic screen) by button combination (see picture).

- Manual control:  
Reversing the channel status to the next automatic or programmed switching.
- Permanent switching:  
As long as a permanent switching (on or off) is activated, the programmed switching times are ineffective

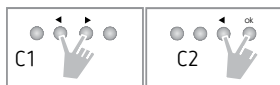

## Activating manual control

- ▶ Briefly press both buttons simultaneously

## Activating permanent switching

- ▶ Press both buttons simultaneously for 2 seconds

## Cancelling manual/permanent switching

- ▶ Press both buttons simultaneously

## Hour counter

The operating hours of the channel (relay) are displayed and deleted in the OPTIONS menu. If the number of operating hours exceeds the value set in the Service menu, SERVICE will appear in the display.

Example: Replace a lamp after after 5,000 h.

- ▶ Delete operating hours or set a higher value in Service (e.g. to 10,000 h)

## Time signal can be received with appropriate top2 RC antenna (only with SELEKTA 171 top2 RC)

- ① The top2 RC-DCF antenna (9070410) and the top2 RC-GPS antenna (9070610) can be connected to the SELEKTA 171 top2 RC time switch.
- ① Follow the advice in the top2 RC-DCF/GPS antenna operating instructions.
- ① Connection to the top2 RC-DCF antenna allows the time switch to be automatically synchronised via DCF signal.



- ① After connecting to the power supply or resetting, the automatic display is changed to as soon as the DCF transmission signal has been received.
- ① Additional power unit (9070892) required for GPS if only one device is connected to the antenna.

## Adjusting of time zones

After successful synchronisation, the time zone can be altered in the TIME/DATE menu option.

- In the TIME menu (display: ALTER HOUR) correct the applicable local time (time zone).

**DCF transmission signal reception:**

**Display:** Day + Month + RC (Radio Control)

**No reception of the DCF transmission signal**

**Display:** e.g. 24 11 07 ⚡

**No connection to antenna:**

**Display:** e.g. 24 11 07

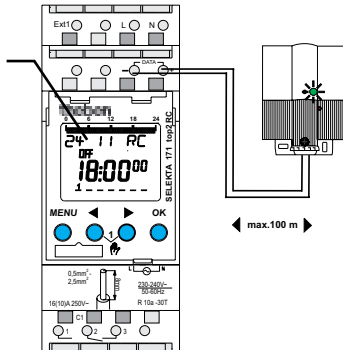

## Using the OBELISK top2 memory card

- ① The OBELISK top2 memory card is not included in the scope of supply of the device, but can be ordered as an accessory (9070404).

All functions can also be set on the PC using the OBELISK software and transferred to the device via the memory card.

- ▶ Insert memory card in the time switch
- ▶ Read in/out saved switching times and device setups in the time switch or start Obelisk program
- ▶ Remove memory card after copying etc.

 Avoid mechanical overload and contamination during storage/transport

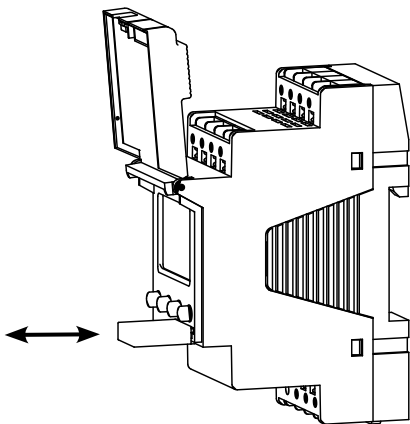

### **Copying OBELISK → Time switch**

This copies the switching programme and optionally all time switch settings (e.g. form time etc.) from the memory card to the time switch.

### **Copying Time switch → OBELISK**

Copies all switching programmes and settings from the time switch to the memory card.

## Starting OBELISK program

Takes over the switching times that are programmed on the memory card.

As soon as the memory card is removed, the switching times of the time switch are re-activated.

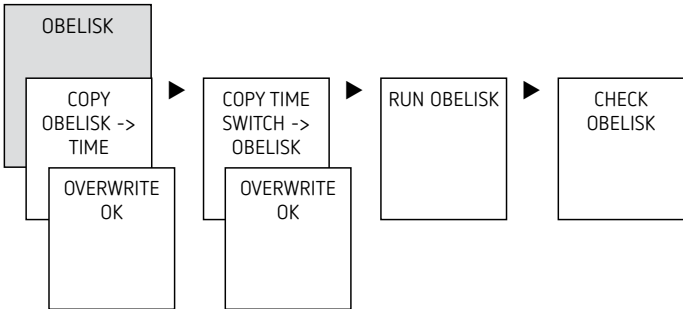

① The current OBELISK top2 PC software are available at [www.theben.de](http://www.theben.de)

## Resetting the time switch

- Press the 4 buttons simultaneously  
→ You can choose between RETAIN PROGRAM and DELETE PROGRAM

## 6. Technical data

Operating voltage	230–240 V AC +10 % / – 15 %
Frequency	50-60 Hz
Standby	1.4 W (1710100) 0.8 W (1720100)
Switching capacity max.	16 A (at 250 V AC, $\cos \varphi = 1$ )
Switching capacity	10 A (at 250 V AC, $\cos \varphi = 0.6$ )
Switching capacity min.	10 mA/230 V AC 100 mA/12 V AC/DC
Protection rating	IP 20 in accordance with EN 60529
Protection class	II in accordance with EN 60730-1 subject to designated installation
Operating temperature	–30 °C ... +55 °C
Shortest switching time	1 min.
Power reserve	10 years at +20 °C
Time accuracy (typical)	$\pm 0.25$ s/day (25 °C)
Contact material	AgSnO <sub>2</sub>
Rated impulse voltage	4 kV
Pollution degree	2
Contact	Changeover contact, $\mu$ contact
Max. switching cycles with 16 A resistive load	50 000
Incandescent lamp load	2600 W
Halogen lamp load	2600 W
Fluorescent lamps (LLB low-loss ballasts): uncompensated series compensated parallel compensated	2300 VA 2300 VA 730 W (80 $\mu$ F)
Fluorescent lamps (EB – Electronic Ballasts):	650 W
Mercury and sodium vapour lamps parallel-compensated	730 VA (80 $\mu$ F)

Compact fluorescent lamps (EB)	170 W
LED lamps (< 2 W)	30 W
LED lamps (2 W – 8 W)	100 W
LED lamps (> 8 W)	120 W
Corresponds to type 1 STU in accordance with IEC/EN 60730-2-7 or IEC/EN 60730-1	
Switching of SELV is only permitted with 171011, not with 1720100	

## 7. Contact

### Theben AG

Hohenbergstr. 32  
72401 Haigerloch  
GERMANY

Phone +49 7474 692-0  
Fax +49 7474 692-150

### Hotline

Phone +49 7474 692-369  
hotline@theben.de

**Addresses, telephone numbers etc.**  
**www.theben.de**

